



COMPONENTES PARA COZINHA



GAVETAS E CORREDIÇAS



REF

CB01

COMPRIMENTO NOMINAL	
300	450
350	500
400	550

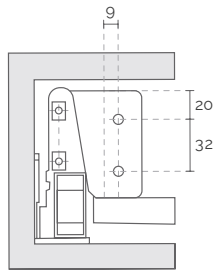

■ ACABAMENTOS



Branco



Cinza

REF

CB01



COMPRIMENTO NOMINAL	
300	450
350	500
400	550

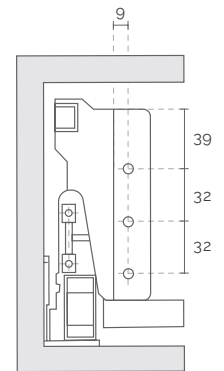

■ ACABAMENTOS



Branco



Cinza

REF

CB2



REF

PAR VARETAS CB01



REF

CB01



EXTRAÇÃO TOTAL
C/AMORTECEDOR

COMPRIMENTO NOMINAL

300	450
350	500
400	550

■ ACABAMENTOS



Branco



Cinza

REF

2 PARES VARETAS CB02



REF

CB3

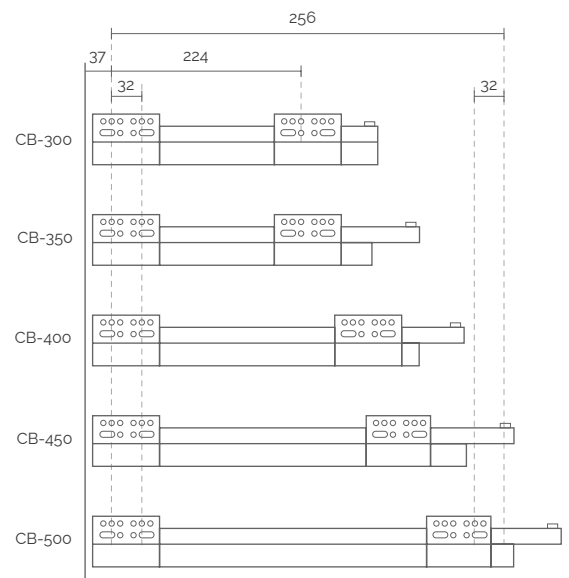
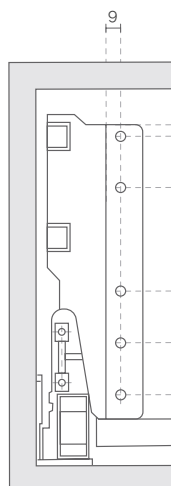

REF **CB5** (1 METRO)

REF **CB4** (1 METRO)



■ CONECTORES FRONTAIS

REF **CB83**

REF **CB142**

REF **CB200**



SLIM

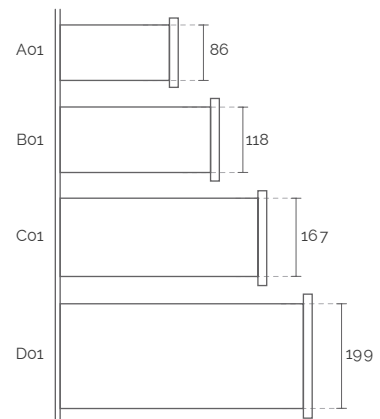

REF.	COMPRIMENTO NOMINAL	
SLIM A01	300	450
SLIM B01	350	500
SLIM C01	400	
SLIM D01		

■ ACABAMENTOS



Branco



Cinza antracite



REF

4513



COMPRIMENTO NOMINAL

45KG

200	500
300	550
350	600
400	650
450	700

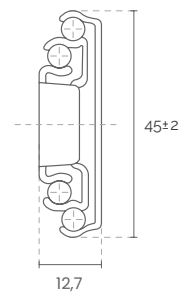

CORREÇÃO DE ESFERAS
EXTRAÇÃO TOTAL

REF

E46



COMPRIMENTO NOMINAL

36KG

300	500
350	550
400	600
450	

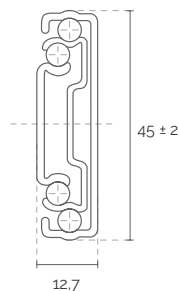

EXTRAÇÃO TOTAL
TIC-TAC

REF

E47



COMPRIMENTO NOMINAL

36KG

300	500
350	550
400	600
450	650

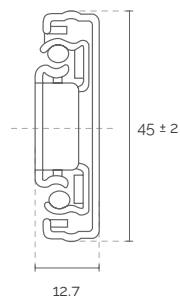

EXTRAÇÃO TOTAL
C/AMORTECEDOR

REF

R683



25KG

■ ACABAMENTOS

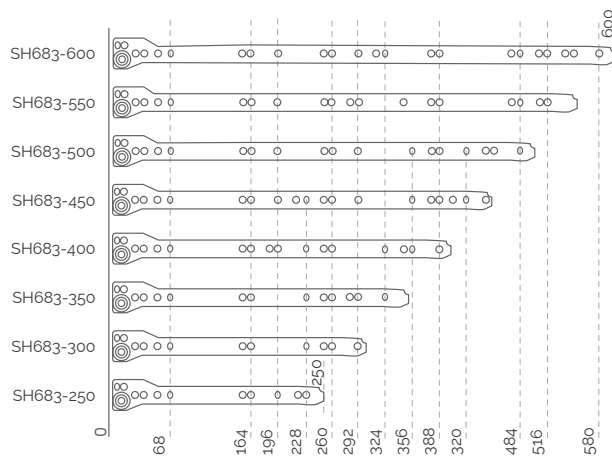

OPÇÃO

SALICE

REF

N3F2



35KG	COMPRIMENTO NOMINAL	
	250	450
300	500	
350	550	
400		

OPÇÃO CORREDIÇAS

DTC

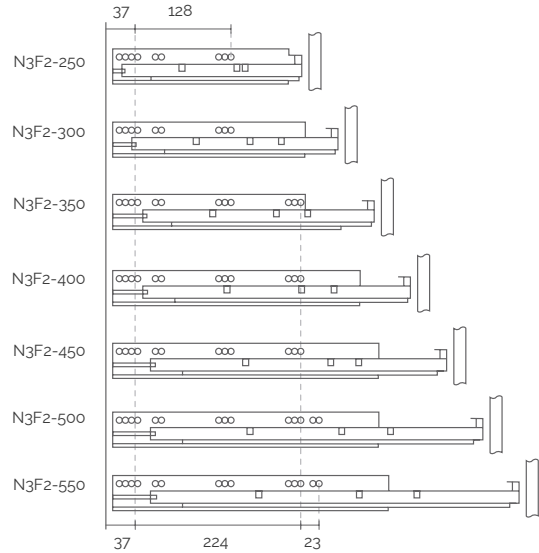

EXTRAÇÃO TOTAL
C/AMORTECEDOR

REF

N2F2



25KG	COMPRIMENTO NOMINAL	
	250	450
300	500	
350	550	
400		

OPÇÃO CORREDIÇAS

DTC

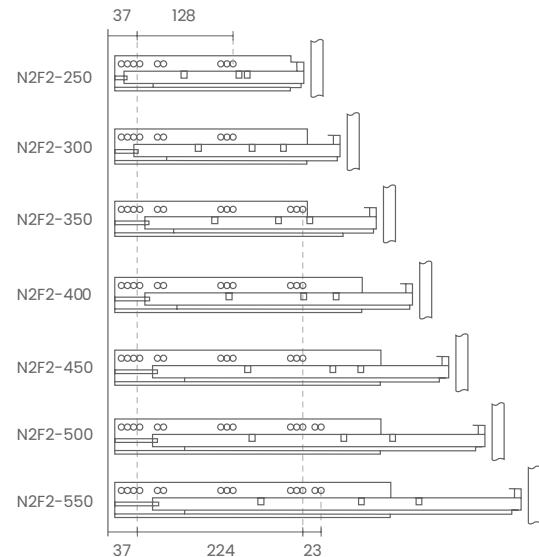

EXTRAÇÃO PARCIAL
C/AMORTECEDOR





CANTOS MÁGICOS E CESTOS

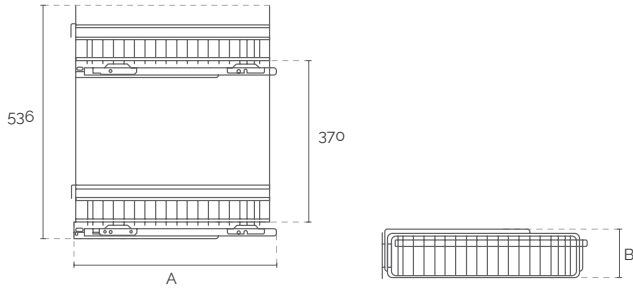

REF

PORTA GARRAFAS INOXA



REF.	B (mm)	A (mm)
15x50	109	
 20x50	156	280
25x50	206	472

CORREDIÇAS



REF

PORTA GARRAFAS



MOD.

15

20

30



REF

PORTA GARRAFAS INOXA

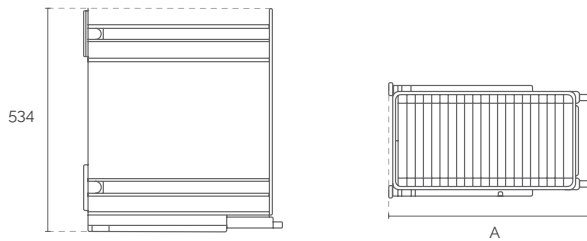

REF.	B (mm)	A (mm)
 30x50	264	477
40x50	364	

CORREDIÇAS



REF

PORTA GARRAFAS PÃO CRM

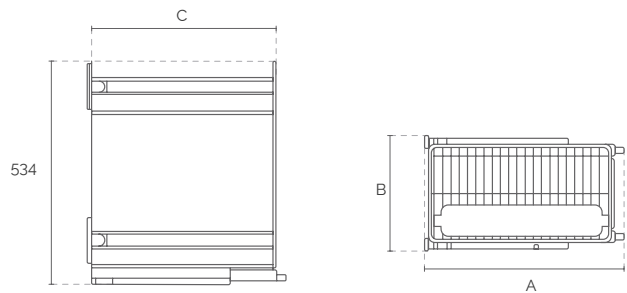

REF.	B (mm)	A (mm)	C (mm)
CRM x30	264	477	444
 CRM x35	314		
CRM x40	364		
CRM x45	414		

CORREDIÇAS



REF

ESTRUTURA P/DISPENSEIRO

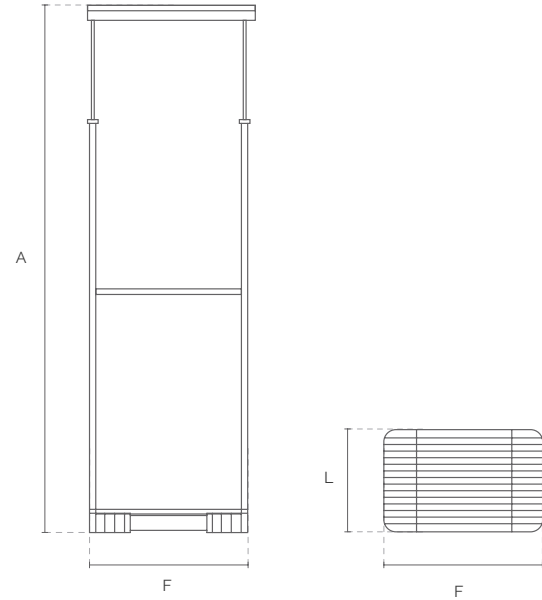

	MOD.	L (mm)	F (mm)	A (mm)
ALTO	300	250	500	1825 2185
	400	350		
	450	400		
	600	550		
MÉDIO	300	250	500	1480 1860
	400	350		
	450	400		
	600	550		
PEQUENO	300	250	500	1135 1495
	400	350		
	450	400		
	600	550		



REF

CESTOS PARA DISPENSEIRO



REF.	L (mm)	F (mm)
30/50	300	500
40/50	400	
45/50	450	
60/50	600	



REF

CESTO MULTIUSOS

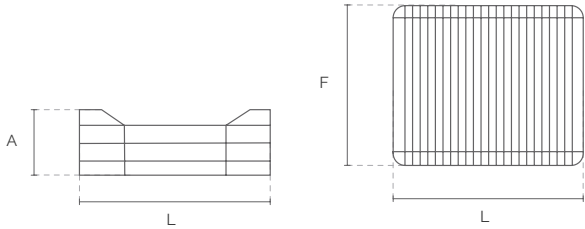

MOD.	L (mm)	F (mm)	A (mm)
300	264	450	170
350	314		
400	364		
450	414		
500	464		
600	564		
800	764		
900	864		



CORREDIÇAS



REF

DINAMIC



DIREITO

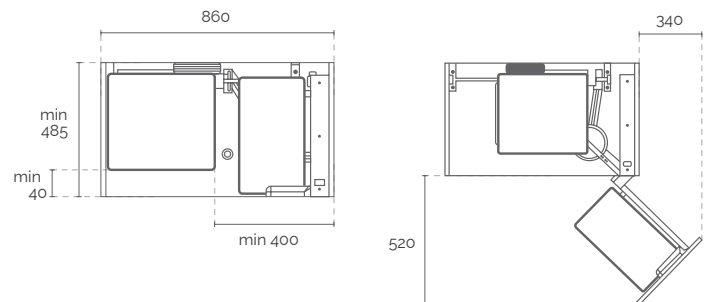

ESQUERDO

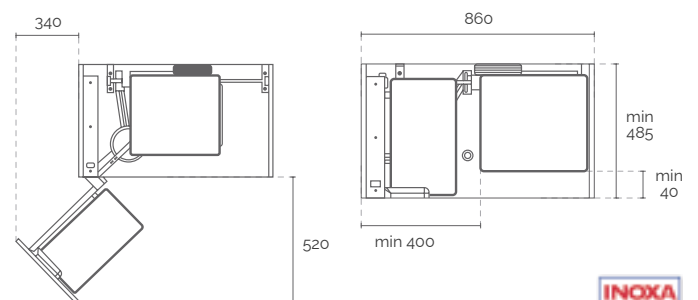

REF

CANTO FEIJÃO

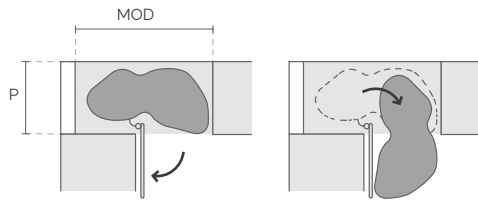

REF

4210 DIREITO

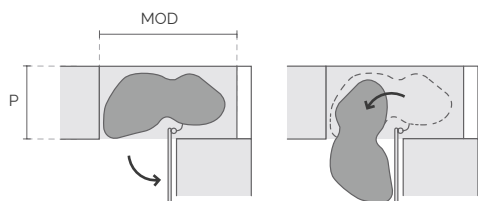

REF

4209 ESQUERDO



MOD.	L (mm)	P (mm)	C/ BANDEJA ANTIDERRAPANTE
900	865	495	

OPÇÃO  KESSEBÖHMER

REF

CESTO GIRATÓRIO 2/4

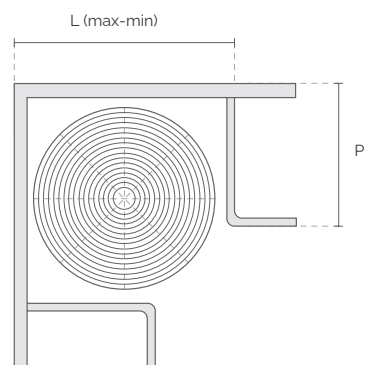

MOD.	Ø (mm)	L (mm)	P (mm)	
	460	500	465	
	510	560-600	525	
600-900	610	660-700	625	360°
	710	760-800	725	
	810	860-900	825	

REF

CESTO GIRATÓRIO 3/4

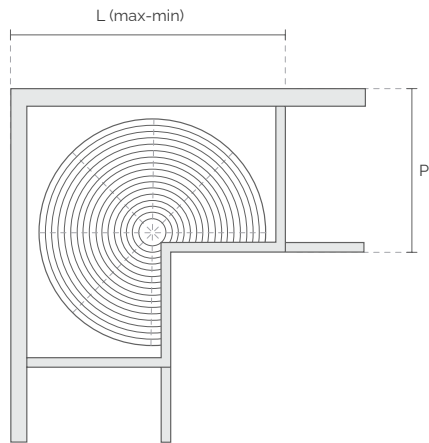

MOD. (mm)	Ø (mm)	L (mm)	P (mm)	
600-900	720	800-600	760	270°
	820	900-600	860	

REF

CESTO GIRATÓRIO 2/4

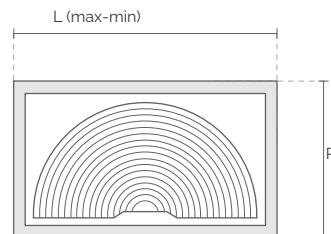

MOD.(mm)	Ø (mm)	L (mm)	P (mm)	
600-900	660	750	700	180°
	740	800	750	
	845	900	850	

REF

TULHA

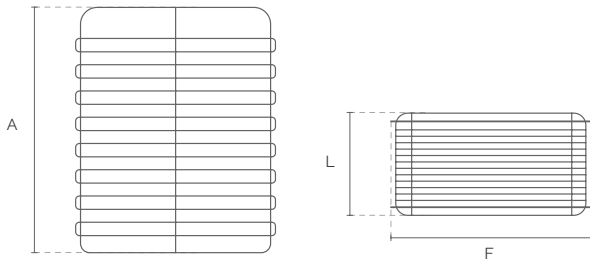

MOD.	L (mm)	F (mm)	A (mm)
300	250		
350	300		
400	350		
450	400	270	400/500
500	450		
600	550		



REF

TULHA EXTENSÍVEL

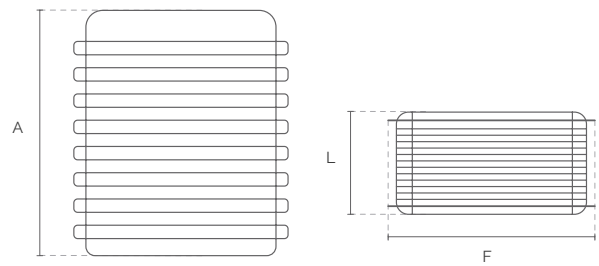

MOD.	L (mm)	F (mm)	A (mm)
300	230		
400	320		
450	380	470	550
600	540		





BALDES DO LIXO



REF

ECOLÓGICO 600

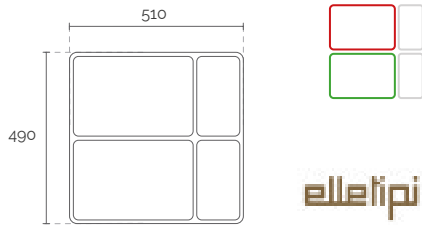

REF

ECOLÓGICO 800

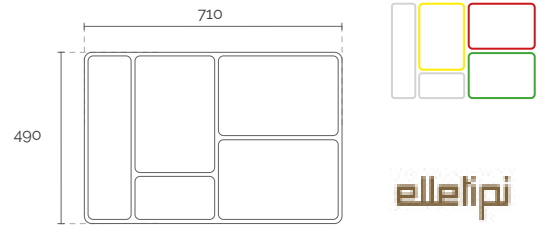

REF

ECOLÓGICO 900

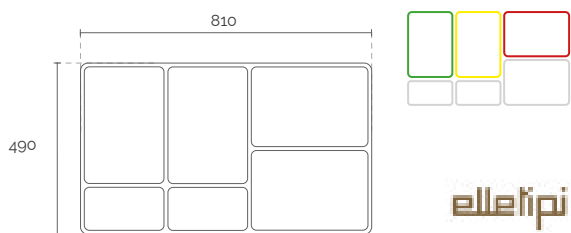

REF

ECOLÓGICO 1200

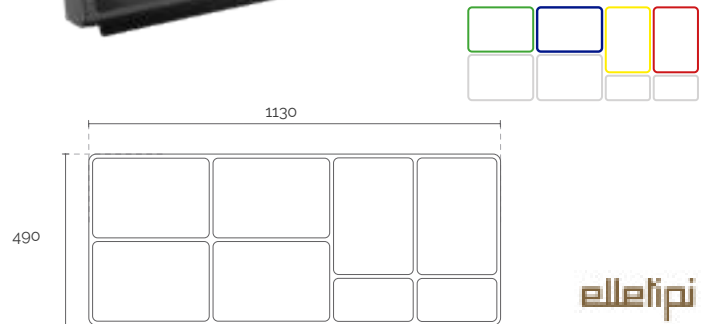

REF **620 X1**

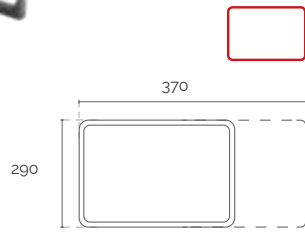

REF **720 X2**

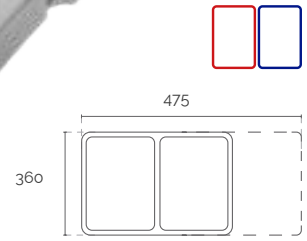

REF **820 X3**

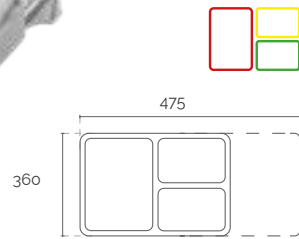

REF **2720**

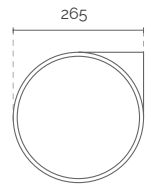

REF **HAILO**

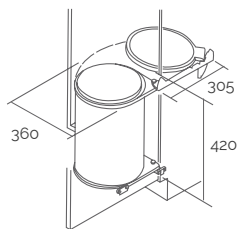



PERFIS



REF **1278**

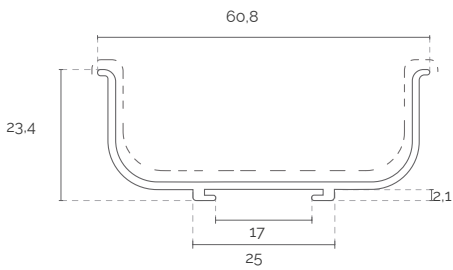
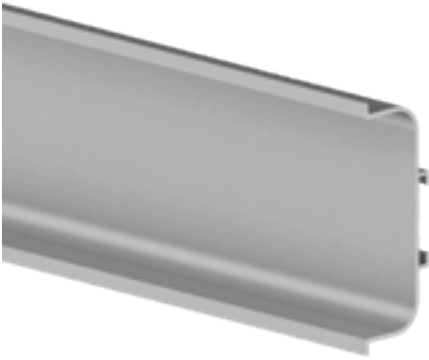

■ ACABAMENTOS



Lacado Branco



Cromado mate



Inox

REF **1279**

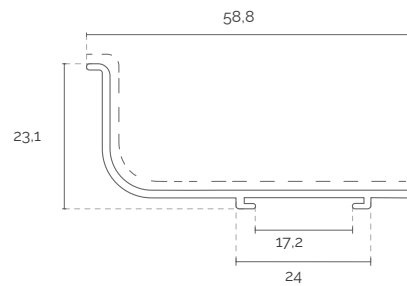
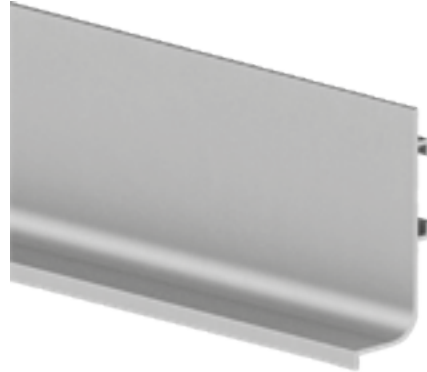

REF **1279** MINI

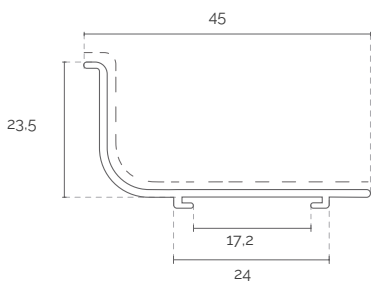
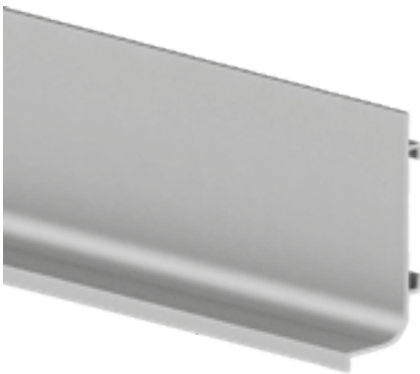

■ ACABAMENTOS



Lacado Branco



Cromado mate



Inox

REF **K108**

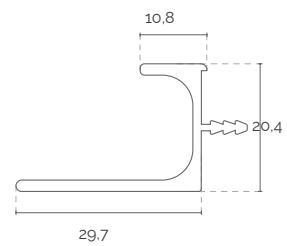
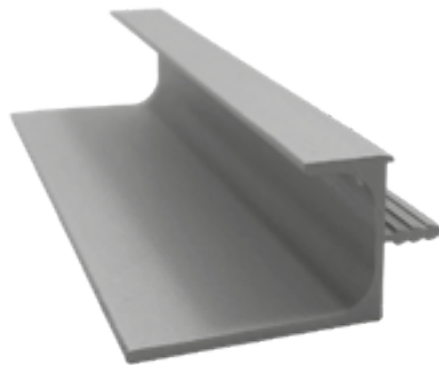

REF

PERFIL VITRINE A COM REFORÇO

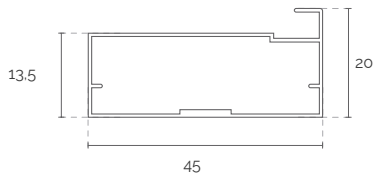
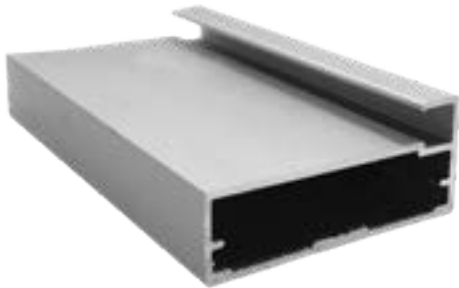

REF

PERFIL VITRINE B

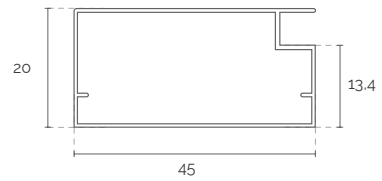

REF

PERFIL RODAPÉ

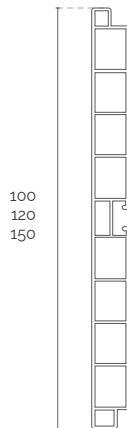

OPÇÃO  

■ ACABAMENTOS



REF

C. FLEXÍVEL 363

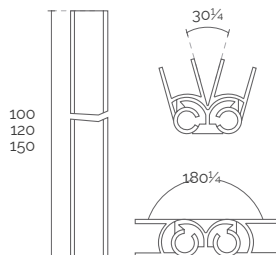

REF

CANTO 663

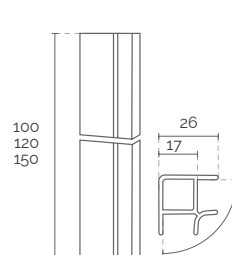

REF

UNIÃO 963

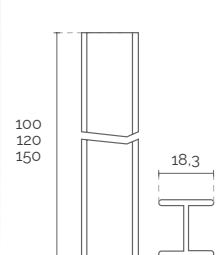



FUNDOS E PORTA-TALHERES



REF

FUNDO ALUMÍNIO

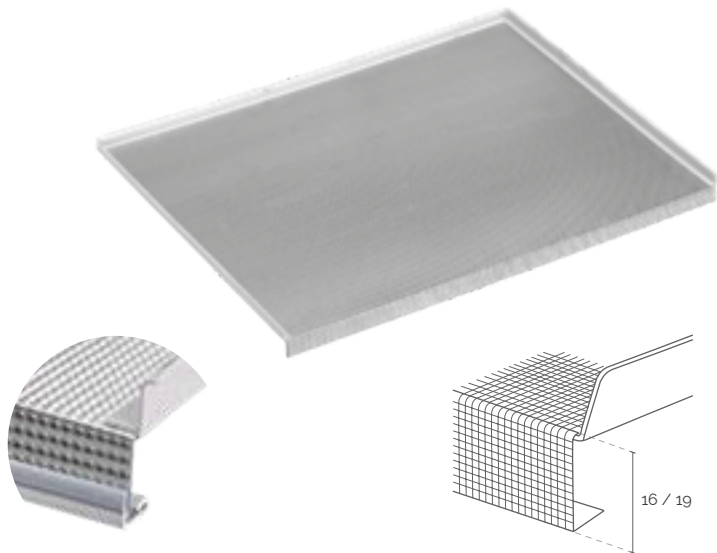

COMPRIMENTO

500	900
600	1000
700	1100
800	1200

■ ACABAMENTOS



Alumínio

REF

PORTA TALHERES



REF.

COMPRIMENTO NOMINAL

	300	700
	350	800
	400	900
METABOX	450	1000
	500	1100
	550	1200
	600	

■ ACABAMENTOS



Branco



Cinza



LAVA LOIÇAS



REF

E37001



■ PROFUNDIDADE DA PIA 190MM

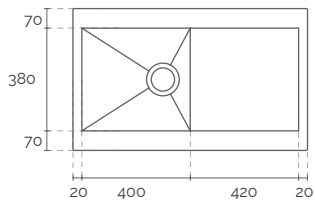

REF

E37003



■ PROFUNDIDADE DA PIA 190MM

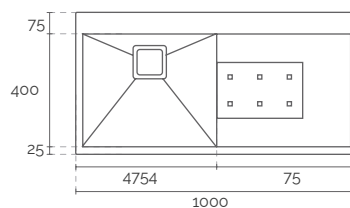

REF

E42082



■ PROFUNDIDADE DA PIA 160MM

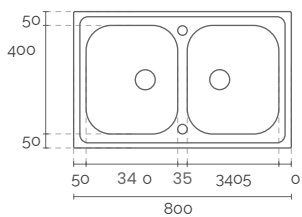

REF

E42100



■ PROFUNDIDADE DA PIA 160MM

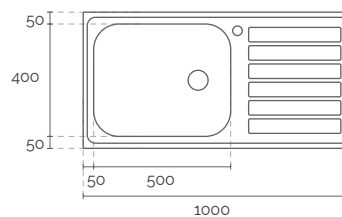

REF

E6045



■ PROFUNDIDADE DA PIA 150MM

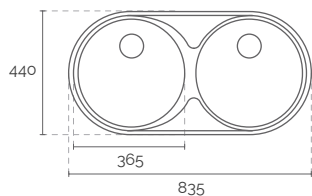

REF

E7045

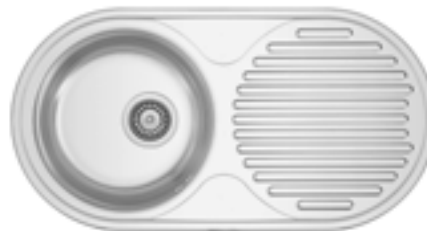

■ PROFUNDIDADE DA PIA 150MM

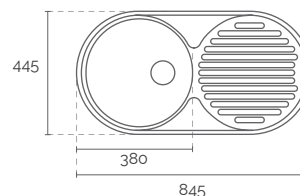

REF

E42080



■ PROFUNDIDADE DA PIA 160MM

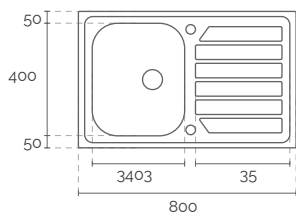

REF

E18001

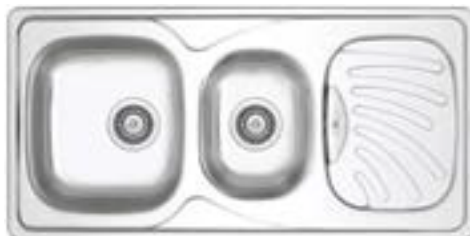

■ PROFUNDIDADE DA PIA 150MM

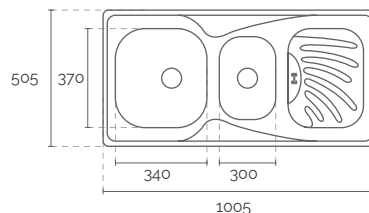

REF

E42102



■ PROFUNDIDADE DA PIA 150/160MM

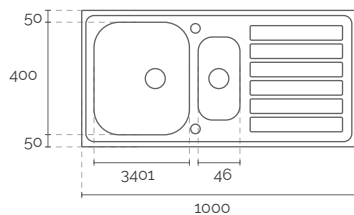

REF

E26001



■ PROFUNDIDADE DA PIA 160MM

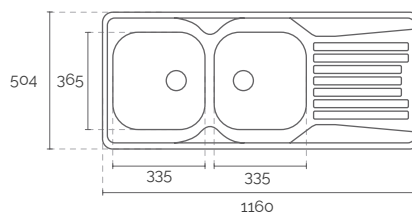

REF

E42120



■ PROFUNDIDADE DA PIA 160MM

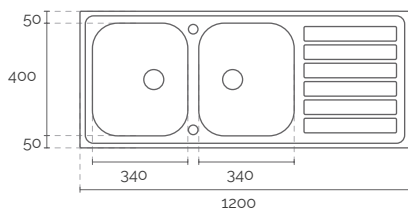

REF

U30001



■ PROFUNDIDADE DA PIA 160/180/200MM

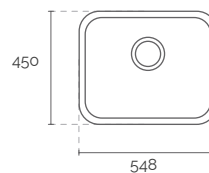

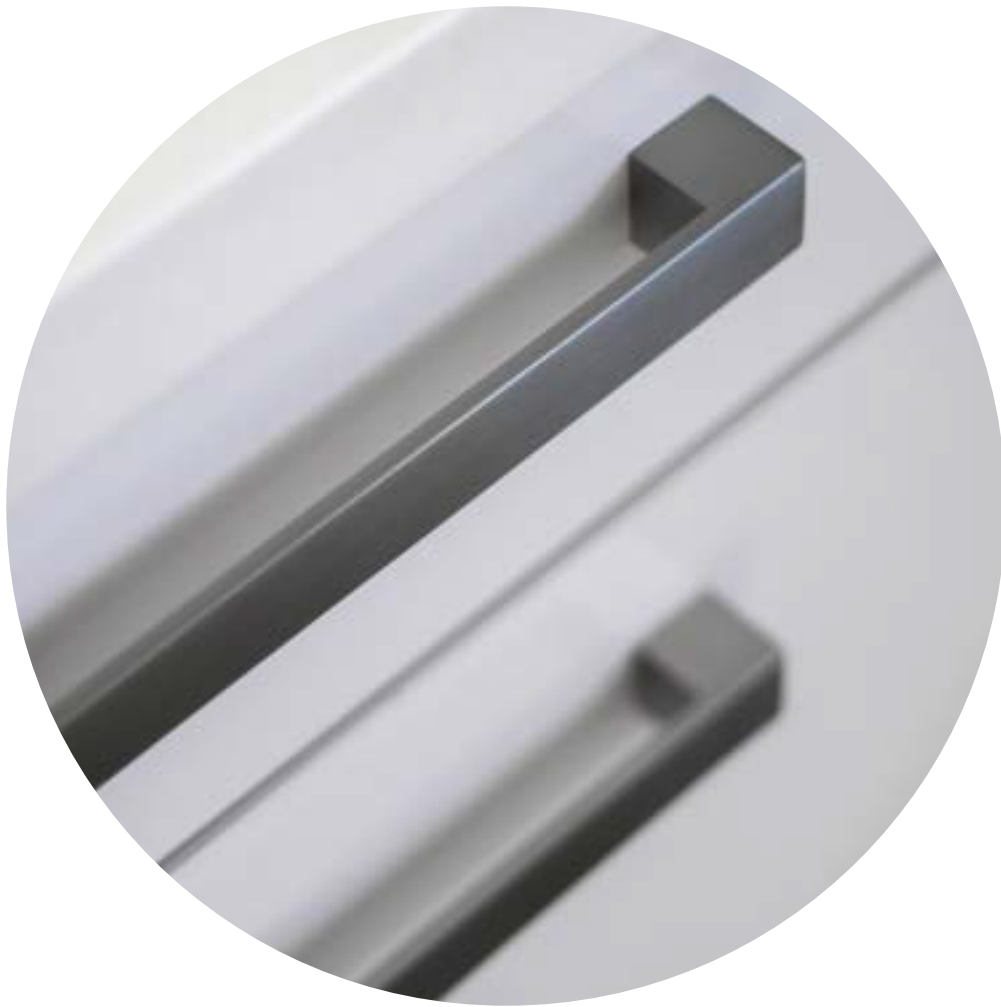

ASAS

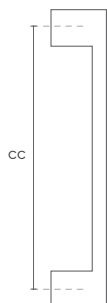

REF

24

CC (mm)

96	160
128	190

■ ACABAMENTOS



Niquelado escovado

REF

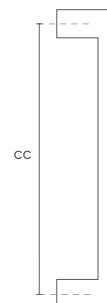
172 AL

CC (mm)

128	190
160	224

■ ACABAMENTOS



Niquelado escovado



Aluminio

REF

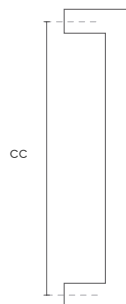
Q106

CC (mm)

128	224
160	320

■ ACABAMENTOS



Niquelado escovado

REF

01X10

CC (mm)

96	320
128	352
160	384
192	448
224	480
242	512
256	586
288	

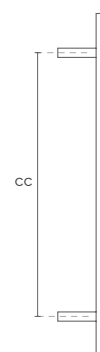

■ ACABAMENTOS



Inox

REF

8014

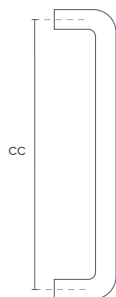

CC (mm)

96	160
128	

■ ACABAMENTOS



Inox

REF

Q100



CC (mm)

128	190
160	224

■ ACABAMENTOS



Niquelado escovado

REF

1604

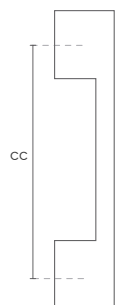

CC (mm)

160	224
192	

■ ACABAMENTOS



Niquelado escovado



Aluminio

REF

Q046

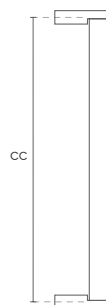

CC (mm)

128	192
160	224
320	

■ ACABAMENTOS



Inox

REF

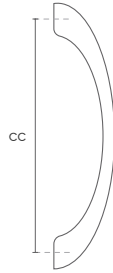
091

CC (mm)

160	224
192	

■ ACABAMENTOS

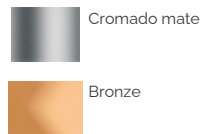

REF

14F

CC (mm)

96 128

■ ACABAMENTOS



REF

1536 X25**1536** X30

■ ACABAMENTOS

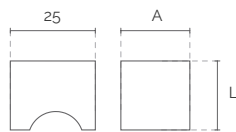

REF

08Q

A (mm) L(mm)

15	15
18	18
20	20

■ ACABAMENTOS

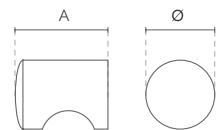

REF

08

A (mm) Ø (mm)

19	12
22	15
24	18
25	20
30	25

■ ACABAMENTOS





DOBRADIÇAS



REF

F07



REF

F07A

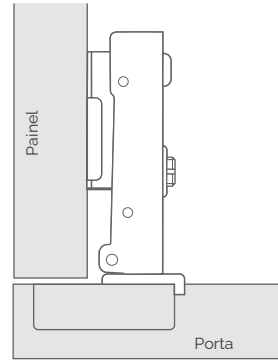

■ INFORMAÇÕES

- Com amortecedor / Soft close
- Opção calço 3D
- Opção calço 2D

REF

F07B

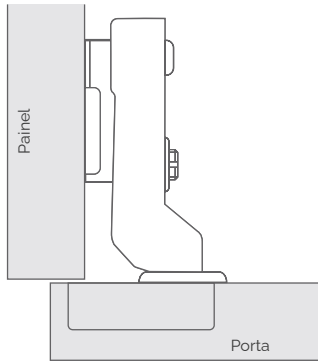

REF

F07C

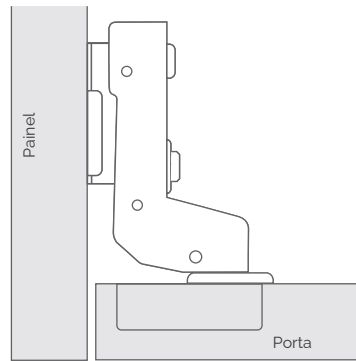

CALÇO 3D



CALÇO NORMAL 2D

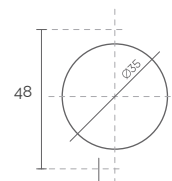
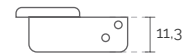

REF

Fo6

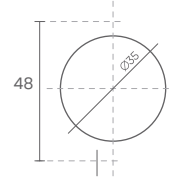

■ INFORMAÇÕES

Com amortecedor / Soft close
Opção calço 3D

REF

Fo6A

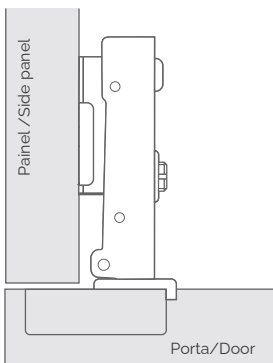

REF

Fo6B

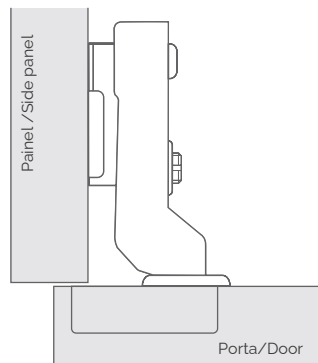

REF

Fo6C

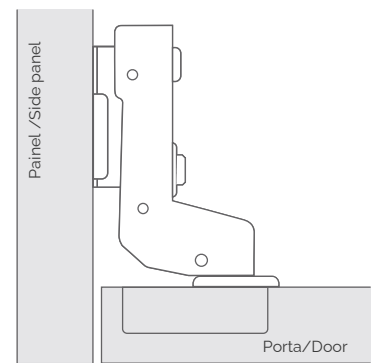

REF

S83A

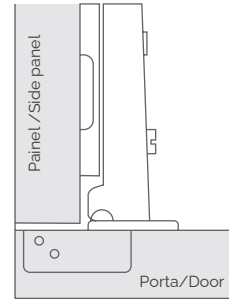

■ INFORMAÇÕES

Sem amortecedor
Calço 2D - embutir

REF

S83B

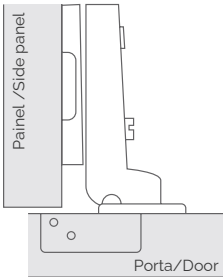

REF

S83C

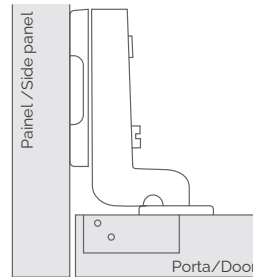

REF

J2



CALÇO NORMAL

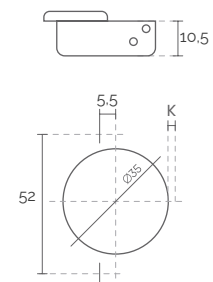

REF

S85A

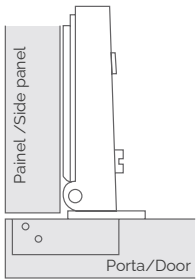

■ INFORMAÇÕES

Sem amortecedor
Calço 2D c/clic

REF

S85B

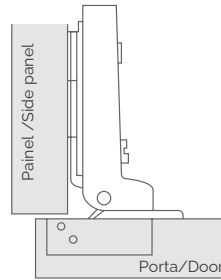

CALÇO NORMAL

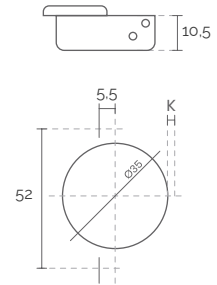

REF

R CURTO

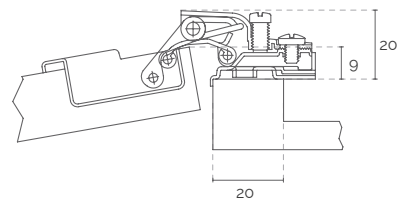
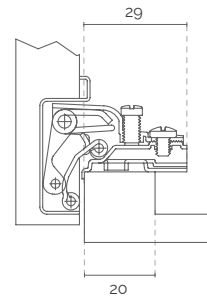

DOBRADIÇA COPO 26°

REF **RECTA**

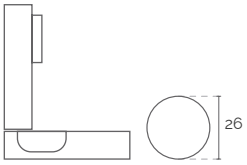

REF **C/8**

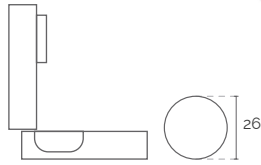

REF **C/TOTAL**

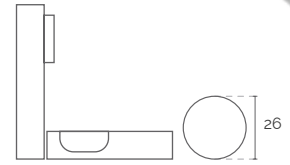

CALÇO NORMAL

REF **90°**

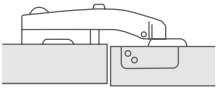

REF **135°**

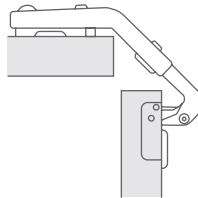

REF **180° - 165°**

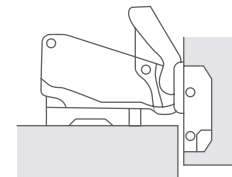

CALÇO NORMAL

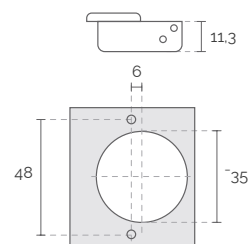



PRODUTOS COMPLEMENTARES DE COZINHA



REF.

200001



MEDIDAS

X100 / X120 / X150



REF.

59426
GRAMPA PLÁSTICO

59423
GRAMPA MADEIRA



X1X



MEDIDAS

X100 / X120 / X150



702



40X1



MEDIDAS

X100 / X120 / X150



P11

MEDIDAS

X100 / X120 / X150



P11

GRAMPA



**59528/
59538**

MEDIDAS

59528 X150 / 59538 X100



97ABC



REF.

202



REF.

1010



F084
X4 FUROS



ESQUADRO
127CL



402



1011



209



K39



210



212



K59



REF.

701



REF.

NIVELADOR



TAMPA
701



COMPASSO
SH106



MEDIDAS

60N / 80N / 100N / 120N / 150N

REF

201



REF

199 8 ELEMENTOS

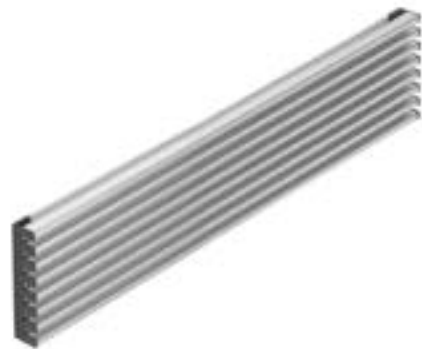

REF.	MEDIDAS
201 G	445X70
201 P	221X70



Cromado mate



Branco

MEDIDAS
125X60
125X90



Inox



Cromado mate



Branco

REF

PÉ MESA

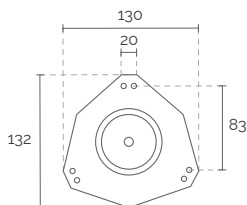

MEDIDAS

80x710 / 80x830 / 80x870

ACABAMENTOS



Nickel satinado



REF

FREE MINI



REF.	DESCRIÇÃO	ALTURA	
0300520	mini A	200/400	0,8/3,8
0300620	mini B	200/400	1,7/6,4
0300720	mini C	200/400	3,2/11,8

REF

FREE FORTE



REF.	DESCRIÇÃO	ALTURA	
0300820	forte D	350/650	3,0/9,6
0300920	forte E	350/650	3,8/12,4
0301020	forte F	350/650	5,7/18,6
0301120	forte G	350/650	7,6/23,6

REF

COMPASSO DE MICROONDAS



REF.	MEDIDAS	
0301720	600	01
0301820	900	
0301920	1200	

REF

SALVA SIFÃO



REF

3T TOMADA DE BANCADA

